

altezza height mm	89,65
angolo degree	88°
raggio radius	0,8
acciaio steel	C45 T HRC 52+58
temprato induzione - induction hardened	
carico load MAX	600 kN/mt

lunghezze lengths	peso weight
mm 835	kg 20,6
mm 415	kg 10,2
mm 805 fraz	kg 19,9
10+15+20+40+50+100+100S+100D+370	

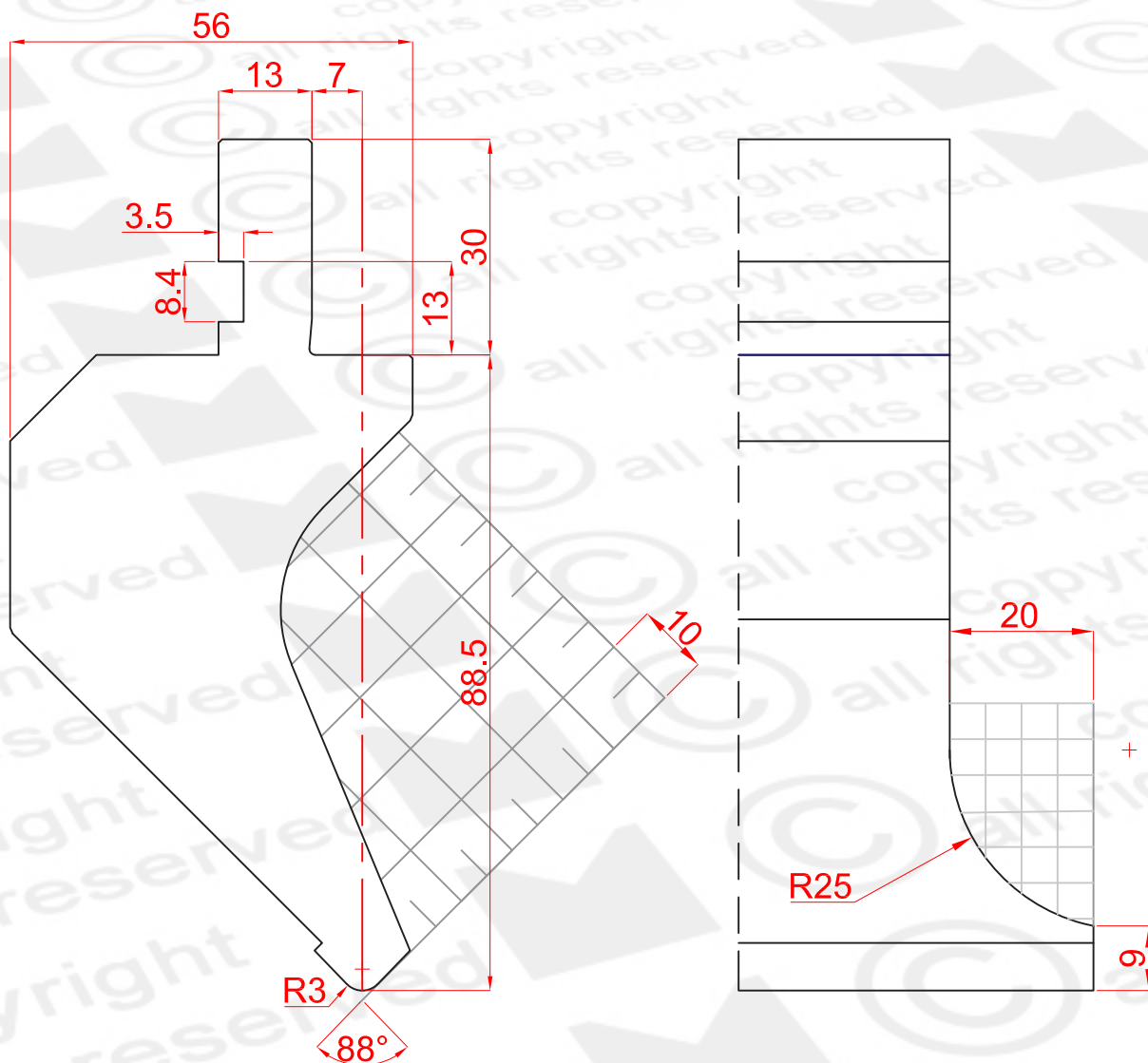



altezza height mm	88,5
angolo degree	88°
raggio radius	3,0
acciaio steel	C45 T HRC 52÷58
carico load MAX	600 kN/mt

lunghezze lengths	peso weight
mm 835	kg 20,5
mm 415	kg 10,2
mm 805 fraz	kg 19,8
10+15+20+40+50+100+100S+100D+370	

